



A Wide-Range RC Oscillator with Push-Button Frequency Selection

IN BOTH laboratory and production work it is common to encounter measuring situations in which it is necessary to make tests at a relatively few test frequencies, but in which these same few frequencies are used again and again. When this is the case, it is advantageous if the test oscillator being used has not only a convenient means for selecting the desired spot frequencies but also a high resetability of output frequency.

A logical approach in designing an oscil-

SEE ALSO:
An Oscillator For Telephone Tests, p. 6
A 0.1 Nanosecond Pulser, p. 7
At Wescon, p. 8

lator tuning system to have high resetability and simplified frequency selection is to design one in which the desired frequencies are selected by push-button switches. Such a system gives quick selection of frequency, eliminates the need for operator dexterity in setting a tuning dial, and all but eliminates the effect of mechanical tolerances which degrade the resetability of the usual variable tuning system. Consequently, the repeatability of a push-button system can be essentially that established by the short- and long-term stability of the oscillator circuit, while the readability, being that of a digital system, is high and at

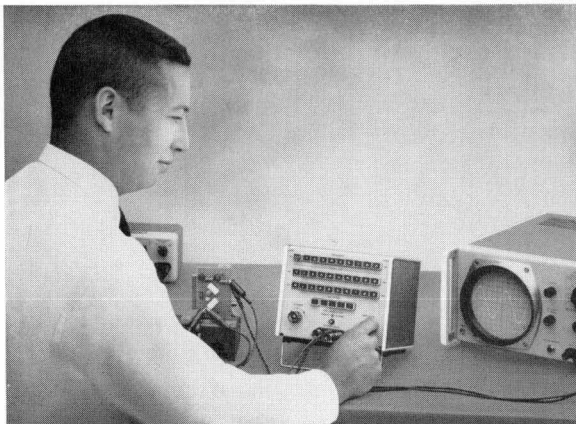

Fig. 1. New -hp- Model 241A Push-Button Oscillator operates from 10 cps to 1 megacycle, facilitates testing where repetition of often-used frequencies is desired. Push-button frequency selection has been used to achieve high repeatability of output frequency.

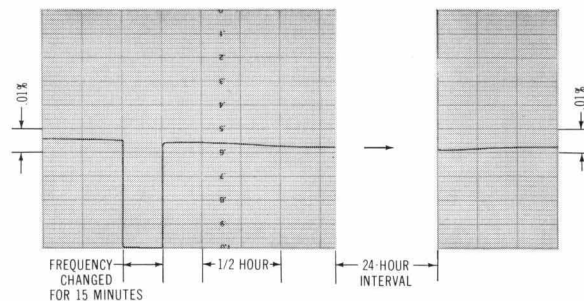

Fig. 2. Record of typical repeatability of output frequency of new 241A Oscillator at 1 kc. First off-scale region occurs when instrument was switched to another output frequency for 15 minutes; interruption in record is where instrument was operated at other frequencies for 24 hours, then switched back to first output frequency. The curve thus demonstrates the high repeatability of output frequency as well as the high frequency stability.

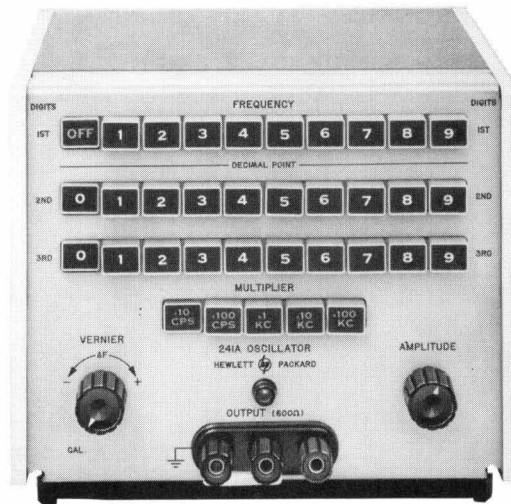

Fig. 3. Panel view of new -hp- Model 241A Push-Button Oscillator. Push-buttons permit selecting 4500 output frequencies from 10 cps to 1 megacycle (999 kc). Frequency vernier provides overlap between switch frequencies.

the same time is appealing to non-technical operators.

The push-button tuning system has been used in the design of a new RC test oscillator that operates from 10 cps to 1 megacycle. Push switches permit selection of frequencies with 3-digit resolution, allowing the oscillator to be reset to any discrete frequency with a precision superior to that achieved with the usual dial tuning. The push buttons provide for 4500 frequencies from 10 cps to 999 kc with high repeatability and 1% accuracy, while a continuous vernier control gives continuous coverage between the digital steps

and also extends the upper frequency limit to 1 megacycle.

Despite the design emphasis on quick frequency selection, emphasis has also been placed on designing the oscillator to be a precision laboratory instrument in every sense. The output frequency accuracy is within 1% and experience has shown the repeatability of frequency settings to be typically well within .04% over 24-hour periods. Total harmonic distortion is below 1% and hum and noise are less than 0.05% of rated output. The instrument provides an output of 5 volts open circuit from a 600-ohm source

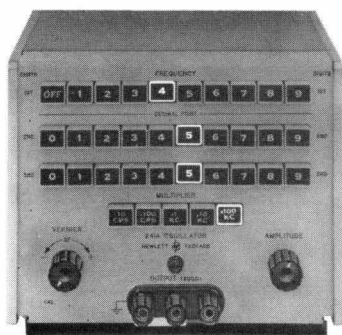

Fig. 4. Photograph indicating method of selecting output frequency in new oscillator. Buttons are set to give output frequency of 455 kc.

impedance, giving 2.5 volts across its rated load of 600 ohms. A variable output attenuator provides an output control range of 40 db.

FREQUENCY SELECTION

The basic circuitry of the 241A push-button oscillator is similar to the previously-described -hp- transistorized RC oscillator¹, except for the method of frequency selection. In both oscillators the frequency of oscillation is determined by a Wien bridge (Fig. 5). When the resistance and capacitance values in the parallel RC arm of the Wien bridge are equal to the resistance and capacitance in the series RC arm, the frequency of oscillation is determined by the relation:

$$f = G/2\pi C,$$

where G is the conductance and C the capacitance in each arm. In the new oscillator the conductances are varied over a 10:1 range by three sets of push-button switches, while a fourth set selects one of five decade ranges by changing the C 's as shown in Fig. 7.

To achieve push-button selection with three significant digits, each conductance is composed of a parallel combination of three conductances, G_1, G_2, G_3 . Using these values, the frequency-determining equation may be written as:

$$f = (G_1 + G_2 + G_3)/2\pi C$$

The most significant digit switch (units digit) selects G_1 from nine multiples of a basic conductance G_0 . The second digit switch (tenths digit) selects G_2 as one of ten multiples of a basic conductance $0.1G_0$, and the third digit switch (hundredths digit) similarly selects G_3 as one of ten multiples of a basic conductance $0.01G_0$. Since G_0 appears as a factor in all three conductances, the

¹D. S. Cochran, "The Transistorized RC Oscillator," Hewlett-Packard Journal, Vol. 13, No. 6, Feb., 1962.

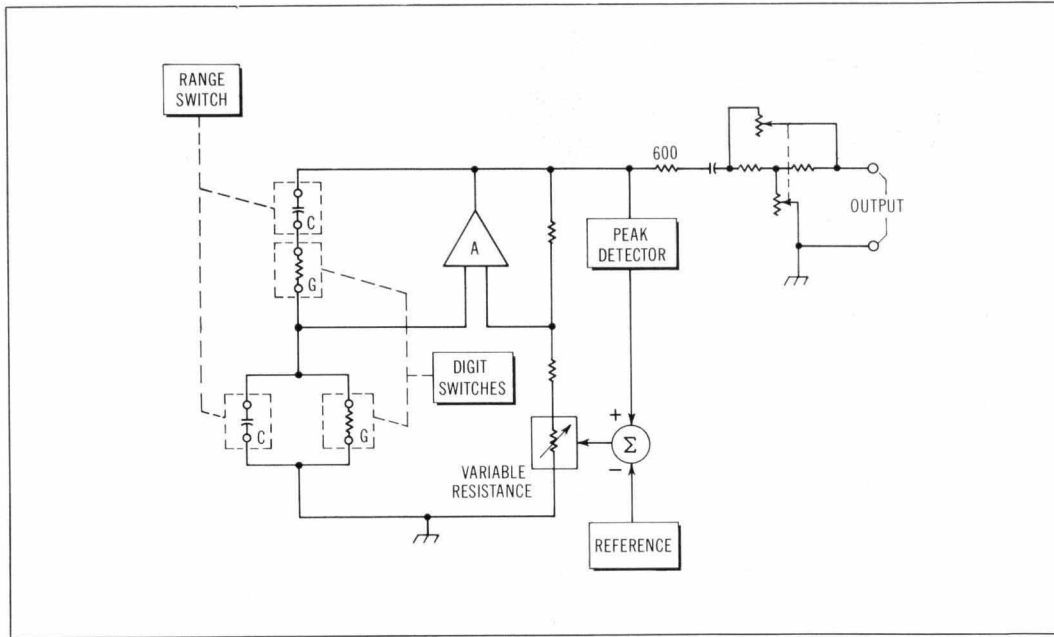

Fig. 5. Basic circuit arrangement of new oscillator. Circuit uses Wien Bridge with amplitude stabilization of amplifier output by a peak detector returned to amplifier input.

frequency expression can be written as:

$$f = (l + 0.1m + 0.01n) G_0 / 2\pi C$$

where l is any digit from 1 to 9 and m and n are digits from 0 to 9. Thus, the top row of push-button switches selects the most significant digit (G_1) of the numerical value of the output frequency, the second row selects the next most significant digit (G_2) and the third row selects the least significant digit (G_3). The range switch selects one of five pairs

of capacitors as decade range multipliers from $\times 10$ to $\times 100$ kc. The vernier control modifies the value of G_1 to provide continuous frequency coverage.

FREQUENCY STABILITY

The exceptional frequency stability of the new oscillator was achieved through careful attention to temperature compensation of Wien bridge components. The G elements are precision metal film resistors whose positive temperature coefficient closely compensates

for the negative temperature coefficient of the range capacitors. The low-range capacitors are hermetically-sealed polystyrene capacitors. Silver mica and temperature-compensating capacitors are used on the higher ranges. The resulting net temperature coefficient of frequency typically lies within the range of 0 to 200 ppm per degree centigrade.

Line voltage fluctuations also affect frequency stability but the effects are small by virtue of a substantial amount of feedback and a regulated power supply. Fig. 8

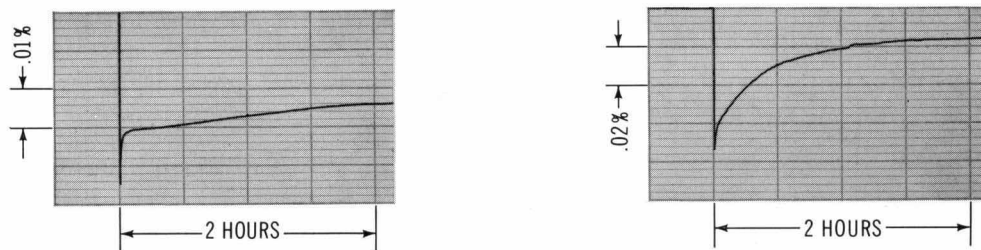

Fig. 6. Curves showing typical turn-on stability at room temperature of new Push-Button Oscillator. Left curve is at 100 cps, right curve at 100 kc.

shows the mid-range frequency stability as the line voltage is varied 10% above and below the normal 115 volt line. This performance is degraded somewhat at the 10 cps and 1 Mc edges of the frequency range.

Instabilities in both frequency and amplitude due to small me-

chanical vibrations and shock are virtually eliminated by the solid-state circuitry and fixed tuning elements. An indication of the overall frequency stability under typical laboratory conditions is given in Fig. 6, which shows the behavior for two hours after initial turn on. Once warmed up, and in normal labora-

tory environment where ambient temperature does not change more than three or four °C over a twenty-four hour period, the frequency stability is typically better than .04% from day to day.

FREQUENCY REPEATABILITY

Because each push-button setting selects a distinct set of fixed tuning elements, the new oscillator achieves a frequency repeatability or resetability feature that is unobtainable from dial type oscillators. To illustrate, suppose the operator makes a measurement at a given push-button setting, say 4.55 x 100 kc, and then goes on to make measurements at other frequencies. After ten minutes or ten hours, he can reselect 4.55 x 100 kc and be assured of obtaining the same frequency as before, within the limits of the short- or long-term frequency stability discussed above.

Some typical repeatability and stability data under normal laboratory conditions are shown in Figs. 2 and 9. The oscillator is offset to another frequency for 15 minutes and then reset to the initial frequency to show the short term repeatability. In all cases the frequency repeated well within .01%. There is a small reset transient due to power dissipation in the tuning elements. The latter portions of the curves show the same frequency setting repeated after a twenty-four hour period of operation at some other frequency. The long-term repeatability is within .04%.

AMPLITUDE STABILITY

The amplitude leveling circuit of the new oscillator compares the peak output voltage to a voltage reference diode and feeds back error information to a resistive control element. The amplifier output level is thereby held constant within ±0.2 db throughout the entire frequency range. The control circuitry is compensated to provide good temperature stability, a 25 °C change in ambient temperature typ-

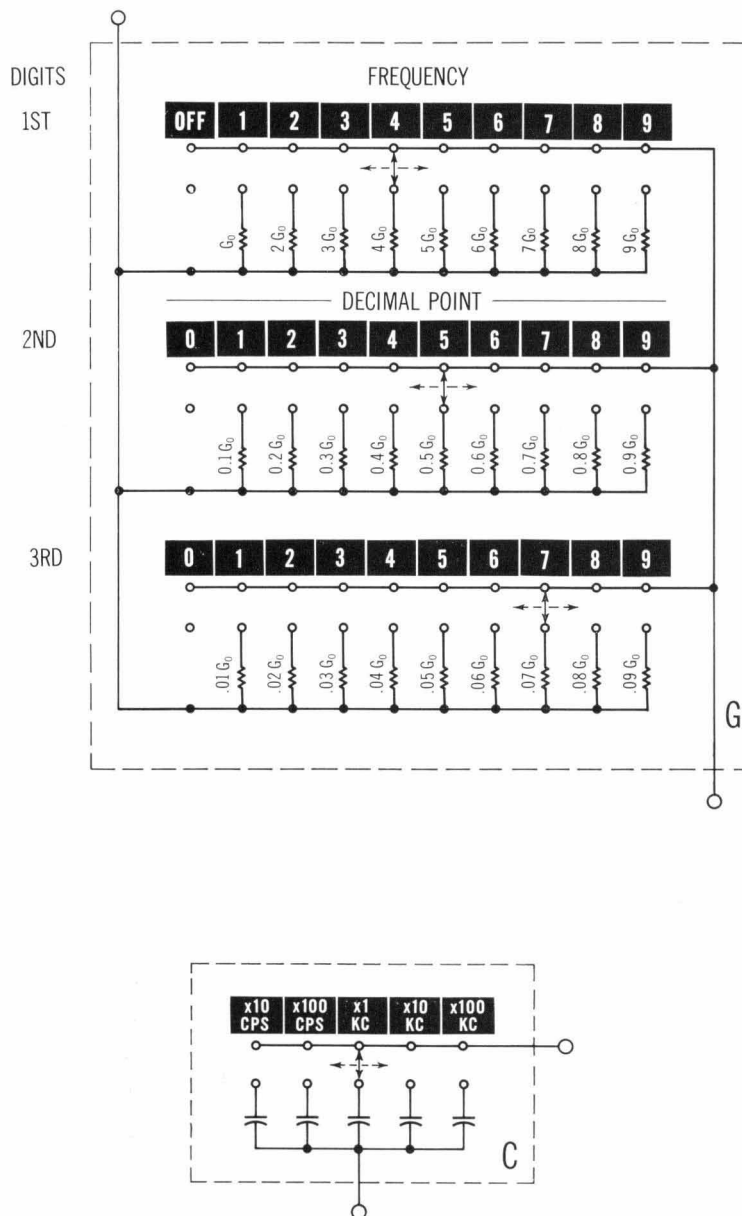

Fig. 7. Drawing indicating arrangement of R and C values in push-button switching circuit.

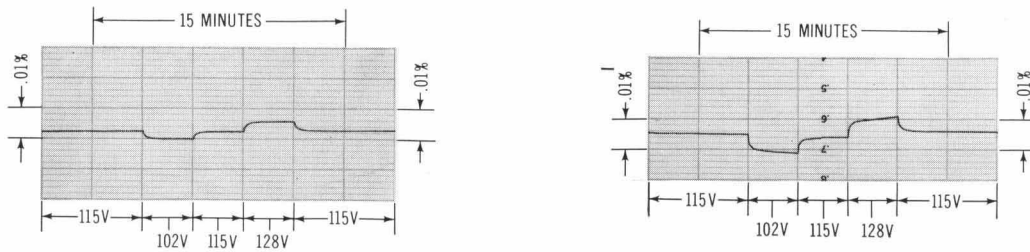

Fig. 8. Curves showing typical small effect of large line voltage changes on output frequency. Left curve measured on 1 kc output frequency, right curve at 100 kc.

ically changing the output level less than 0.1 db.

OUTPUT CIRCUIT

A variable bridged-T attenuator (Fig. 5) maintains a constant 600-ohm output impedance throughout an attenuation range of +10 dbm to -30 dbm. Capacitive coupling between the output amplifier and the attenuator eliminates dc in the output signal.

The 241A circuitry is isolated from chassis ground and the shielded power transformer provides good isolation from the power line. Removal of the ground strap on the front panel permits the output terminals to be floated off ground.

GENERAL

Physically, the 241A is compact and portable. The cabinet, of the -hp- modular enclosure design, is suitable for bench use and also fits one-half of a standard 7 inch rack panel with a sub-module rack adapter. Covers are easily removed for routine maintenance and the two plug-in printed circuit boards provide good accessibility.

The instrument operates from either a 115- or 230-volt 50-1000 cps line and, being transistorized, consumes but one watt.

The new oscillator was developed in the Palo Alto laboratories of Hewlett-Packard by L. D. Austin, D. S. Cochran, H. F. Grotzinger, and the undersigned.

—Robert W. Colpitts

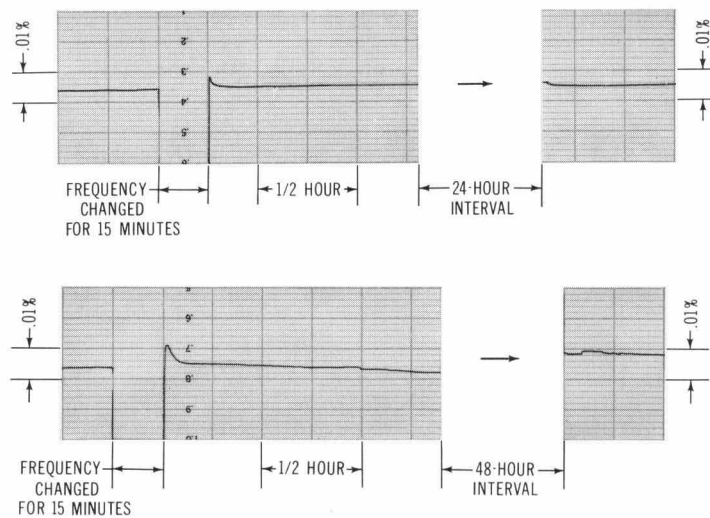

Fig. 9. Repeatability and stability curves similar to Fig. 2 measured on new oscillator at operating frequencies of 10 kc (upper) and 1 megacycle (lower). Note 48-hour rather than 24-hour interval in lower curve.

SPECIFICATIONS

-hp-

MODEL 241A

PUSH-BUTTON OSCILLATOR

Frequency: 10 cps to 1 Mc, 5 ranges, 4500 frequency increments with vernier overlap.

Calibration Accuracy: $\pm 1\%$.

Frequency Response: $\pm 2\%$ into rated load.

Output Impedance: 600 ohms.

Distortion: 1% maximum.

Hum and Noise: 0.05% of output.

Output: +10 to -30 dbm into 600 ohms (2.5 volts max).

Power: 115 or 230 volts, 50 to 1000 cps, 1 watt.

Dimensions: 7-25/32 in. wide, 6 1/2 in. high, 8 in. deep.

Weight: Net 8 lbs. Shipping 13 lbs.

Accessories Available: -hp- 11000A Cable, 44" long, dual banana plugs, \$4.50 -hp- 11001A Cable, 45" long, dual banana plug to BNC, \$5.50. -hp- 11002A Test Leads, 60" long, dual banana plug to alligator clips, \$7.50.

Price: -hp- Model 241A, \$425.00.

Prices f.o.b. factory

Data subject to change without notice

SPECIAL PUSH-BUTTON AUDIO OSCILLATOR FOR TELEPHONE TESTING

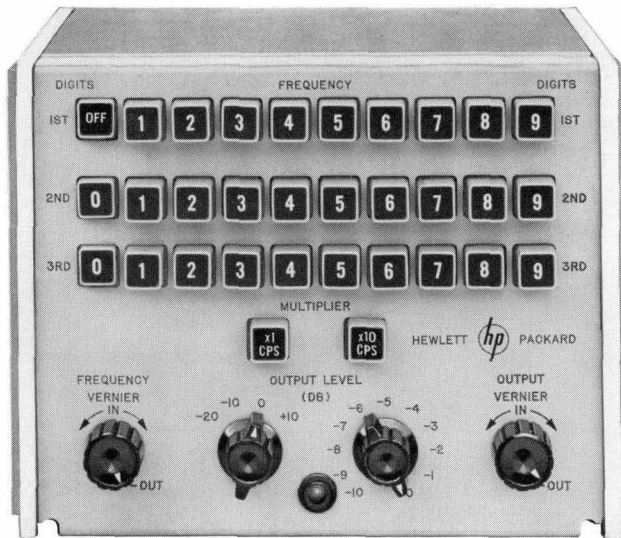

Fig. 1. Push-button oscillator for telephone test work operates from 10 cps to 10 kc with an absolute accuracy of $\pm 0.2\%$. Instrument matches 600- and 900-ohm lines, operates from -48 vdc supply.

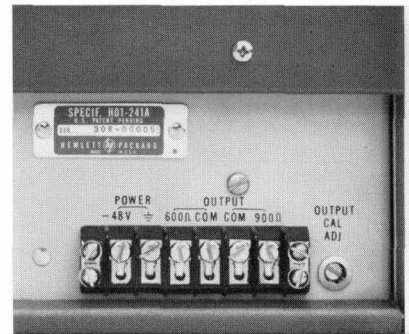

Fig. 2. Input and output terminal arrangement on instrument rear panel.

A special-purpose version of the push-button oscillator described earlier in this issue has been designed for telephone testing applications. The circuitry of the special oscillator is generally similar to that of the parent instrument but a number of application features have been included that facilitate telephone work. The instrument's frequency coverage, for example, is from 100 cps to 10 kc with an absolute accuracy of $\pm 0.2\%$ over the $55^\circ - 95^\circ\text{F}$ temperature range.

Other special adaptations for telephone work include an output circuit arrangement that has two sets of output terminals to match either 600- or 900-ohm lines. Both of these outputs are balanced to ground and the impedance of each is held within 5% of nominal over the complete frequency range. The phase angles of the source impedances are held

within 5° of that of a true resistive source.

The output circuit includes a combined L- and T- pad which has two outputs to match either 600- or 900-ohm loads and to provide equal power to each. The pad is preceded by two step attenuators which together adjust output power over a 40-db range ($+10$ to -30 dbm) in 1 db steps having an overall accuracy of 0.1 db. A continuous vernier control overlaps the 1 db steps to provide infinite resolution.

A rear panel control permits calibration of the output power level. Power level variations caused by frequency changes are less than ± 0.2 db. Overall power output accuracy following calibration is within 0.5 db of the attenuator setting, including the effects of frequency change, $\pm 5^\circ\text{F}$ temperature variations, ± 4 volt supply variations,

and a change from one output impedance to the other. Because of the excellent temperature and line voltage stability of the oscillator's amplitude control circuit, calibration is maintained for long periods.

BATTERY OPERATION

The oscillator is arranged to operate from the standard 48 volt (positive ground) telephone equipment battery supply. Steps have been taken to minimize the effects of battery voltage variations so that typical frequency changes for battery variations of ± 4 volts are less than 0.003% from nominal. The transformer-coupled output circuit allows the output terminals to be floated up to 500 volts dc off ground.

ENHANCED STABILITY

In the frequency-determining networks (see Fig. 5 of main article) wire-wound resistors have been

used to achieve tight control of temperature coefficient of frequency. The resulting temperature coefficient is typically less than 60 ppm/degree C. This has permitted the 0.2% absolute frequency accuracy over a 40°F range. The low temperature coefficient combined with other measures gives the overall instrument a performance which is about twice as high as that shown by the stability and repeatability curves in the main article on the parent instrument.

The instrument is packaged in the -hp- ½ rack width cabinet which has been modified for mounting in the telephone equipment rack.

—Robert W. Colpitts

SPECIFICATIONS

-hp- MODEL HO1-241A PUSH-BUTTON OSCILLATOR

Frequency: 100 cps to 10 kc, 2 ranges.

Frequency Accuracy: Within ±0.2% from 55°F to 95°F, within ±0.3% from 45°F to 55°F and 95°F to 105°F. Vernier in OUT.

Frequency Response: Within ±0.2 db over entire range.

Output Power: +10 to -30 dbm, in 10 and 1 db steps. Vernier is at least 1 db.

Output Stability: Within ±0.1 db for at least 3 hours, temperature within ±5°F. Within ±0.5 db when including effects of frequency response, input voltage changes, and output power difference between 600 Ω and 900 Ω with each impedance terminated in its nominal impedance.

Distortion: At least 40 db below fundamental output.

Noise: At least 65 db below total output.

Output Circuit: Balanced and floating. May be operated at voltage up to 500 vdc above chassis ground.

Output Impedance: 600 and 900 ohms, ±5%, selectable. Maximum phase angle is ±5°.

Balance: At least 70 db at 100 cps, 55 db at 3000 cps.

Input Power: 48 vdc ±4 vdc, positive side grounded.

Dimensions: 7-25/32 in. wide, 6½ in. high, 8 in. deep.

Net Weight: Approximately 8 lb.

A TUNNEL-DIODE PULSE GENERATOR WITH 0.1 NANOSECOND RISETIME



Fig. 1. Tunnel-diode pulse generator provides voltage steps with 0.1 nanosecond risetime for testing very fast systems. Repetition rate can be up to 100 kc.

TRANSIENT response testing of wideband systems and components, by observation of the output waveform resulting from a voltage step input, has become one of the most widely used techniques for evaluating the performance of such systems. Since waveform degradation is the principal indicator of system performance, the quality of the input step is of paramount importance. This step should have a risetime significantly faster than the system under test, and should have minimum overshoot and ringing.

To fulfill these requirements in measurements carried out in the nanosecond time region, the new -hp- 213B Pulse Generator generates pulses with risetimes faster than 0.1 nsec, the fastest risetime yet achieved in a production instrument. The pulse top is flat within 2% for the initial 100 nsec of pulse duration, producing an ideal waveform for step response testing. Pulse amplitude is 175 mv into a 50-ohm system or 350 mv into an open circuit and either positive-going or negative-going pulses are available. Pulse width is fixed at 2 μsec.

MATCHED SOURCE IMPEDANCE

Another important consideration in transient response testing concerns the source impedance of the pulse generator. Source impedance has become of increasing concern since the advent of oscilloscopes, such as the -hp- 185A/B sampling scopes, which can distinguish events separated in time by fractions of a nanosecond. Pulse reflections from impedance mismatches in coaxial or transmission line systems are clearly revealed by these scopes. These reflections often serve a useful purpose since their shape and amplitude convey information on the nature of the impedances on either side of the mismatch¹. A mismatch at the generator end of the system, however, causes re-reflections which may be superimposed on the primary reflections in the CRO display. To prevent re-reflections, the pulse generator has an effective 50-ohm source impedance which absorbs any reflections returning through the interconnecting 50-ohm cable.

¹"Transmission Line Testing Using the Sampling Oscilloscope," Hewlett-Packard Application Note No. 53.

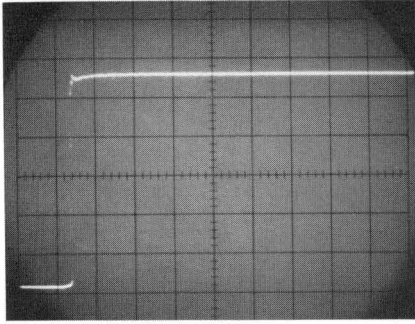

Fig. 2. Oscilloscope taken at relatively slow sweep speed of 10 nsec/cm to show flat top of voltage step from -hp- 213B Pulse Generator. Output can be positive or negative. Oscilloscope taken on -hp- 185B Sampling Oscilloscope.

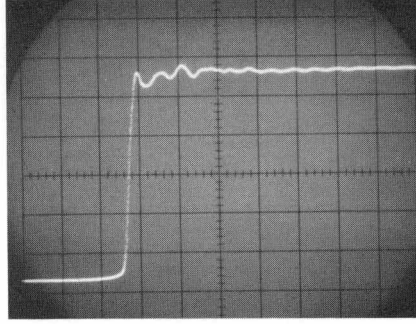

Fig. 3. Sweep speed of 0.5 nsec/cm shows very fast rise of -hp- 213B Pulse Generator output. Minimum-length signal paths were used in observation set-up, although it is quite small for such a fast step.

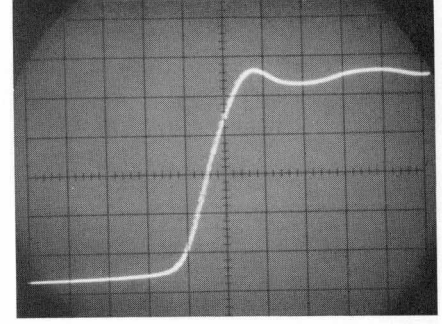

Fig. 4. Very fast sweep speed of 0.1 nsec/cm shows low trigger-to-pulse jitter of 213B Generator when triggered by -hp- 185B Sampling Oscilloscope. Oscilloscope sampled several hundred pulses during exposure to display leading edge. Apparent risetime of step includes finite scope risetime.

The new generator is a higher-speed version of an earlier tunnel-diode pulse generator (-hp- 213A), which had been developed as a special-purpose generator for step-response testing of the -hp- 185 series sampling oscilloscopes. However, the fast-rising step, trigger sensitivity, low jitter, and high repetition rate of this generator made it also attractive for a variety of other low-amplitude pulse measurements, such as transmission-line measurements and switching-time measurements on low-level components.

Until the advent of the 213A, the mercury-wetted relay was the most reliable generator of steps with sub-nanosecond risetimes. Relay pulse generators are limited to relatively slow pulse repetition rates, though, which either results in dim displays on real-time oscilloscope, with the fast sweeps necessary for fast risetimes, or in flickering displays when used with sampling scopes. The 213A Pulse Generator, and consequently the new 213B, are capable of being triggered at rates anywhere from 0 to 100 kc/s with low jitter and are able to run free at repetition rates in excess of 100 kc.

The 213B is well-suited as a companion instrument to the 185B oscilloscope for low-level pulse measurements.

-Roderick Carlson

SPECIFICATIONS

-hp- MODEL 213B PULSE GENERATOR

OUTPUT:

RISE TIME: Less than 0.1 ns.
TOP DROOP: Less than 2% in first 100 ns following the rise.
WIDTH: Approximately 2 μ s.
AMPLITUDE: Greater than 175 mv into 50 ohms, 350 mv open circuit, either polarity.
SOURCE IMPEDANCE: 50 ohms.
JITTER: Less than 20 picoseconds when triggered with the 185A or 185B sync pulse.
REPETITION RATE: Free runs at a rate greater than 100 kc, or may be triggered.

TRIGGER INPUT:

AMPLITUDE: 0.5 volt peak, either polarity.

RISE TIME: 20 ns or faster.
WIDTH: At least 2 ns.
MAXIMUM CURRENT: 200 ma peak.
IMPEDANCE: 200 ohms for signals less than 0.75 volt peak. Limiting lowers impedance to larger signals.
REPETITION RATE: 0 to 100 kc.

GENERAL:

POWER: 115 or 230 volts \pm 10%, 50 to 60 cps, approximately 1 watt.
DIMENSIONS: 1 1/2 in. high 5 1/8 in. wide, 5 in. deep.
WEIGHT: Approximately 2 lb. net.
PRICE: \$215.00.

Prices f.o.b. factory.
Data subject to change without notice.

VISIT -hp- AT WESCON

Readers attending the WESCON show in San Francisco, Aug. 20-23, are cordially invited to visit our booths where -hp- engineers from the laboratories and the field will be on hand to discuss measurement matters with you.

At the booths, too, will be several important new -hp- measuring instruments. One is a sophisticated new general-purpose oscilloscope which has a range of measurement capabilities that makes it a basic tool of interest to everyone.

Other new instruments to be displayed include a 2500-megacycle converter plug-in for the -hp- transistorized frequency counter, a digital voltmeter with a variety of plug-ins, and an rms voltmeter with a response to 8 megacycles.

Most -hp- divisions and affiliates including Boonton Radio, F. L. Moseley Co., and Sanborn Co. will be on aisle 2000 on the main floor, right side.

-hp-'s Dymec Division and Harrison Laboratories will be on aisle 2700 in the adjoining South Exhibit Hall.